



JOR212 Series

60V MOSFET Output Photorelay

Description

The JOR212 PhotoRelay consist of a MOSFET、Photoelectric generator optically coupled to an infrared LED 。

Block Diagram and Package

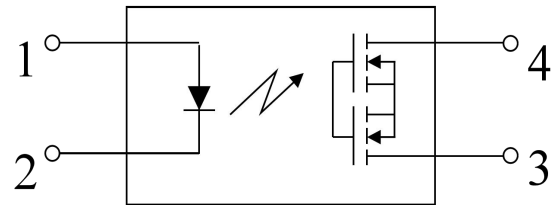

Features

- Normally opened (SPST)
- Control 60V AC or DC voltage
- Switch 500mA load
- Controls low-level analog sings
- High sensitivity, low conductivity resistance
- Low-level off state leakage current
- High isolation voltage 3750V
- Pb free and RoHS compliant

PIN DEFINITION



- 1: Anode (LED)
- 2: Cathode (LED)
- 3, 4: Drain (MOS FET)

Application

- Communications products (personal computers, laptops)
- Modem/sensor
- Mobile phones/security equipment
- Measuring and testing equipment
- Plant automation equipment
- High-speed inspection machines

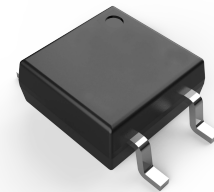
PACKAGE OUTLINE



ORDERING AND MARKING INFORMATION	
MARKING INFORMATION	
	<p><b>JOR</b> : Company Abbr.  <b>212</b> : Part Number  <b>Y</b> : Fiscal Year  <b>A</b> : Manufacturing Code  <b>WW</b> : Work Week</p>
ORDERING INFORMATION	LABEL INFORMATION
<p><b>JOR212(Y)(Z)-G</b></p> <p><b>JOR</b> – Company Abbr  <b>212</b> – Part Number  <b>Y</b> – Lead Form Option (M/S/SL/None)  <b>Z</b> – Tape and Reel Option (T1/T2)  <b>G</b> – Green</p>	

**Absolute Maximum Ratings (T<sub>A</sub>=25°C)**

Parameter		Symbol	Rating	Unit	Note
Input	LED Forward Current	I <sub>F</sub>	50	mA	
	LED Reverse Voltage	V <sub>R</sub>	5	V	
	Peak Forward Current	I <sub>FP</sub>	1	A	f=100 Hz, Duty factor= 0.1%
	Power Dissipation	P	75	mW	
Output	Load Voltage (peak AC)	V <sub>L</sub>	60	V	
	Continuous load current (peak AC)	I <sub>L</sub>	0.5	A	
	Peak load current	I <sub>peak</sub>	1.5	A	100 ms (1 shot), V <sub>L</sub> = DC
	Power Dissipation	P <sub>out</sub>	300	mW	
I/O isolation voltage		V <sub>iso</sub>	3750	Vrms	
Temperature limits	Operating Temperature	T <sub>opr</sub>	-40°C ~ + 85°C	°C	Non-condensing at low temp
	Storage Temperature	T <sub>stg</sub>	-40°C ~ + 100°C		

**Electro-optical Characteristics (Ta=25°C)**

Parameter		Symbol	Condition	Min.	Typ.	Max.	Unit
Input	LED turn on current	$I_{Fon}$	$I_L=0.5A$	0.5	0.75	3	mA
	LED turn off current	$I_{Foff}$	$I_L=0.5A$	0	0.55	3	mA
	LED dropout voltage	$V_F$	$I_F=5mA$	1	1.3	1.4	V
Output	On resistance	$R_{on}$	$I_F=5mA, I_L=0.5A,$ Within 1s on time	-	0.9	1.5	$\Omega$
	Off state leakage current	$I_{Leak}$	$I_F=0mA, V_L=60V$	-	-	1000	nA
Transfer Characteristics	Turn on time	$T_{on}$	$I_F=5mA, I_L=0.5A$	0.2	0.36	2	ms
	Turn off time	$T_{off}$	$I_F=5mA, I_L=0.5A$	0.05	0.14	1	ms
	I/O capacitance	$C_{iso}$	$f=1MHz, V_B=0$	-	0.8	1.5	pF
	Initial I/O isolation resistance	$R_{iso}$	500V DC	1,000	-	-	M $\Omega$

Note: Recommendable LED forward current value:  $I_F=5$  to 10mA

**Typical Performance Curves**

**Fig.1 Load current vs. Ambient temperature characteristics**

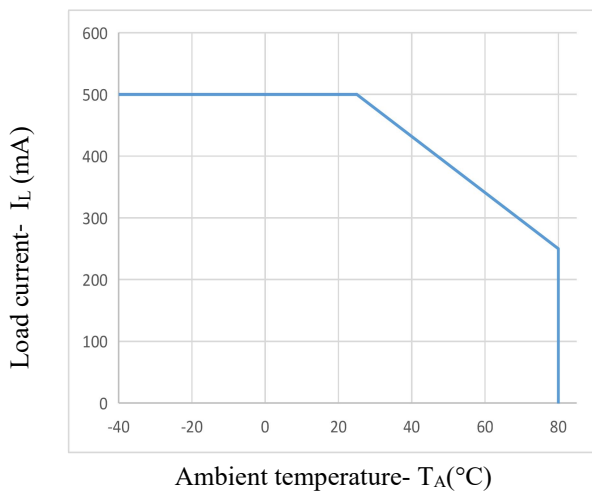

**Fig.2 On resistance vs. Ambient temperature characteristics**

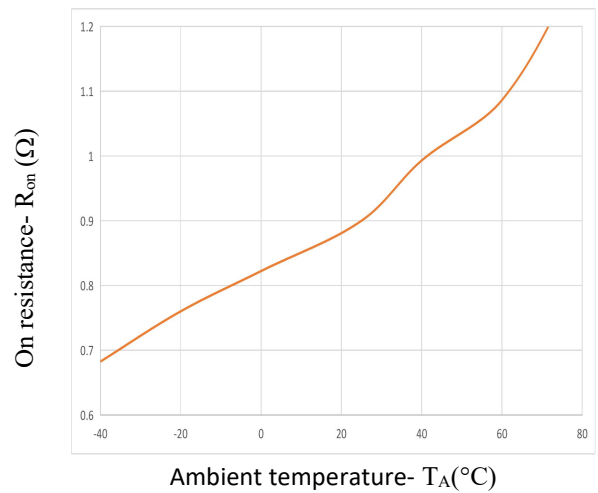

**Fig.3 Turn on time vs. Ambient temperature characteristics**

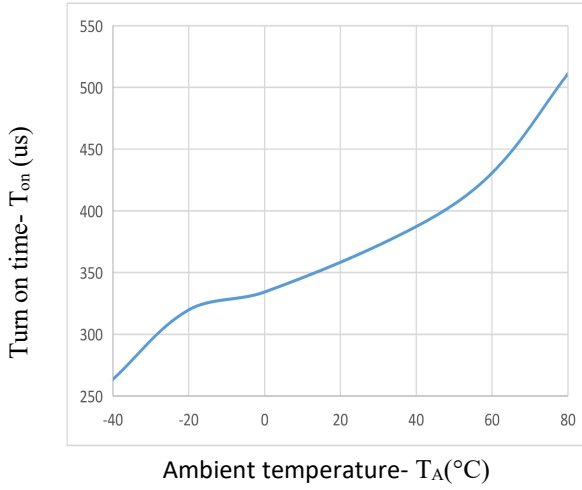

**Fig.4 Turn off time vs. Ambient temperature characteristics**

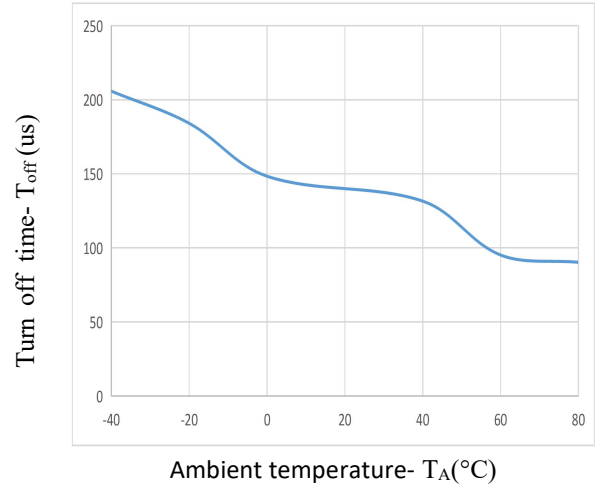

**Fig.5 LED turn on current vs. Ambient temperature characteristics**

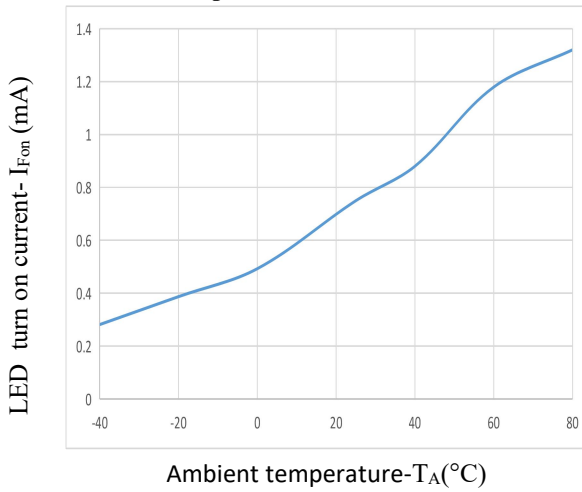

**Fig.6 LED turn off current vs. Ambient temperature characteristics**

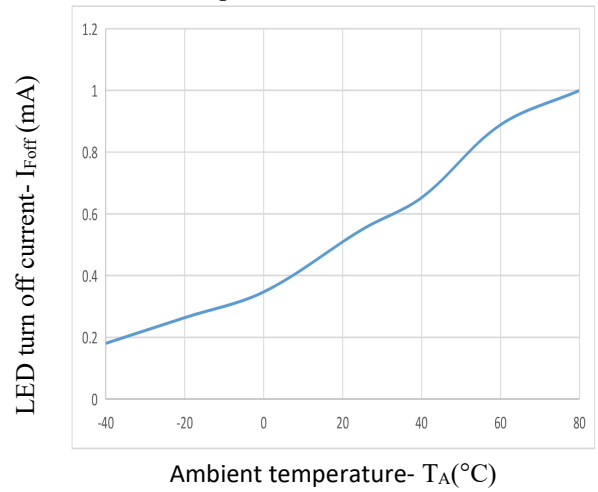

**Fig.7 LED dropout voltage vs. Ambient temperature characteristics**

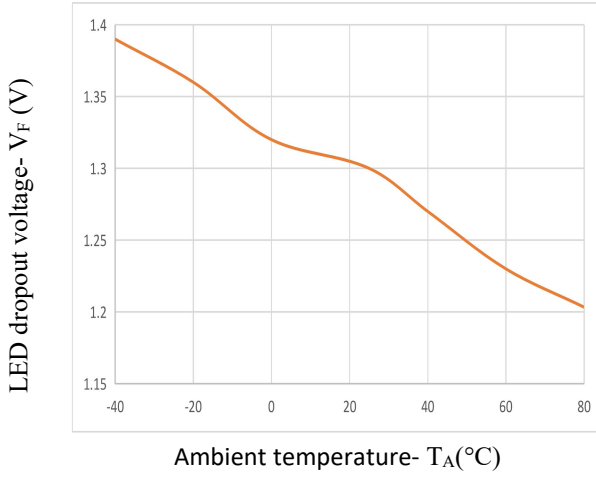

**Fig.8 Output current vs Output voltage**

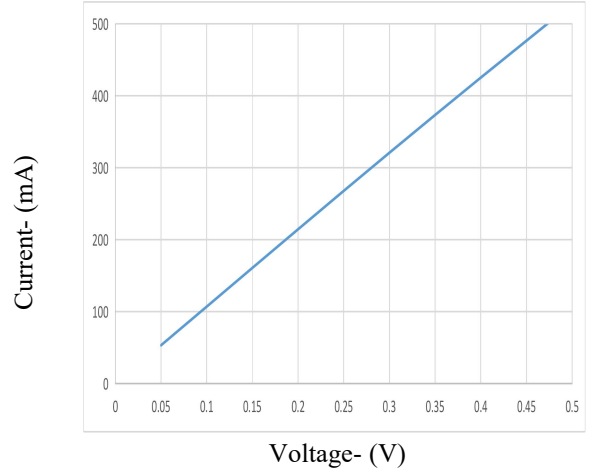

**Fig.9 Off state leakage current vs Load voltage characteristics**

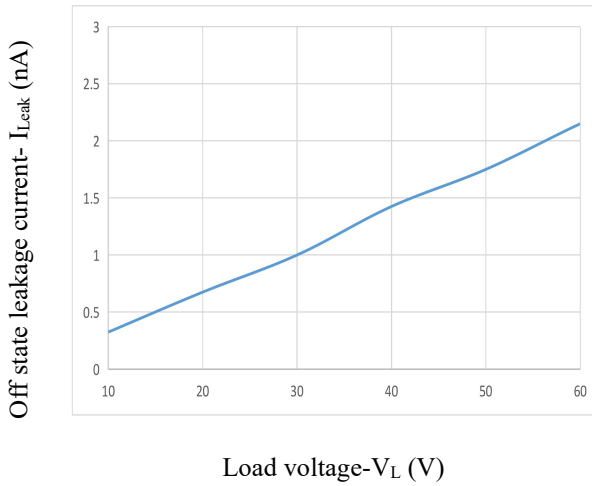

**Fig.10 LED turn on time vs Forward current characteristics**

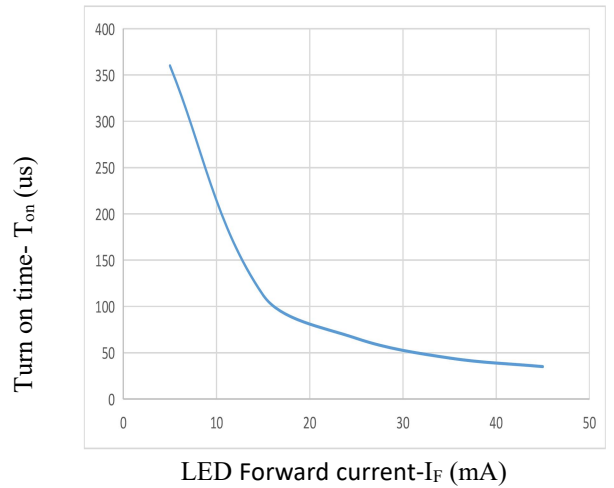

**Fig.11 LED turn off time vs Forward current characteristics**

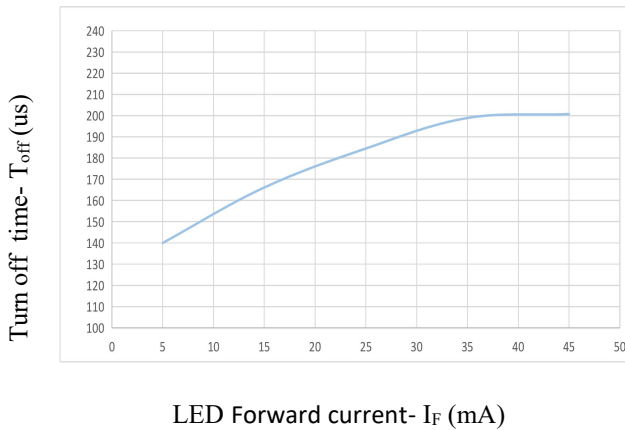

★ Turn on/off time

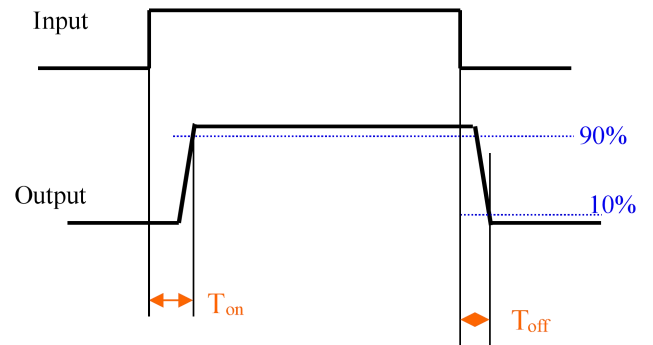

**Solder Reflow Profile**

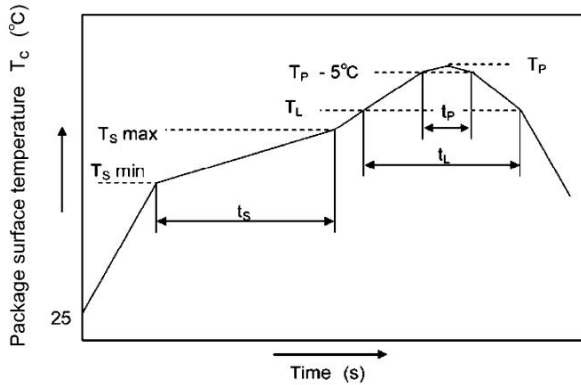

	Symbol	Min	Max	Unit
Preheat temperature	$T_s$	150	200	°C
Preheat time	$t_s$	60	120	s
Ramp-up rate ( $T_L$ to $T_P$ )			3	°C/s
Liquidus temperature	$T_L$	217		°C
Time above $T_L$	$t_L$	60	150	s
Peak temperature	$T_P$		260	°C
Time during which $T_c$ is between ( $T_P - 5$ ) and $T_P$	$t_p$		30	s
Ramp-down rate ( $T_P$ to $T_L$ )			6	°C/s

**Outline Dimensions**

Unit: mm

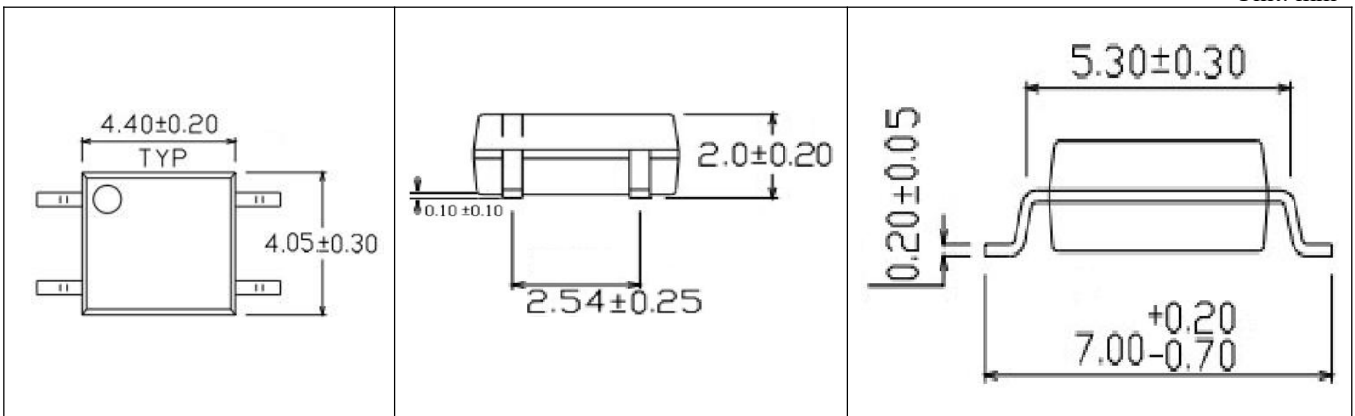

4-pin SOP

**Packing**

Package Type	Packing Form	Quantity per Reel	Quantity per Box	Quantity per Carton	Antistatic Bag Specification	Box Specification	Carton Specification	Note
SOP-4	Reel (φ330mm Blue)	3k pcs/reel	2 reels /box	10 boxes /ctn	380*380mm	340*60*340mm	620*360*365mm	Guard band 200mm min.

■ SOP-4 (Reel)

- 1) Qty/ctn: 60000 pcs
- 2) Qty/reel: 3000 pcs
- 3) Inner packing: 2 reels /box
- 4) Schematic: (unit: mm)

